

Applied Optoelectronics in Medicine

Aplikovaná optoelektronika v lékařství

Interdisciplinary course at the CTU Prague (P317APL-E, W, 4 credits)

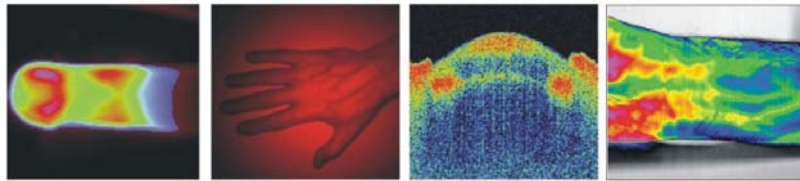

3. Metrological aspects in optoelectronics, light perception 3. Metrologické aspekty optoelektroniky, biofyzika vnímání světla

© V. Blazek, MedIT, 2017
All rights reserved
Lecture 3, Page 1

Scriptum AOM: Applied Optoelectronics in Medicine

RWTHAACHEN
UNIVERSITY

Learning aims of the third AOM lecture

- Metrology, optoelectronics, photonics - definitions
- Radiation intensity, optical power, radiometry, photometry
- Light perception, sensitivity of the human eye, objective and subjective color valuation
- Eyes in animal kingdom

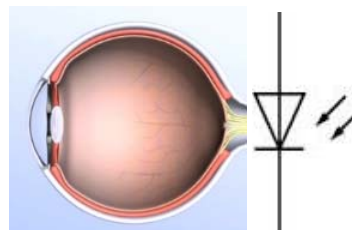
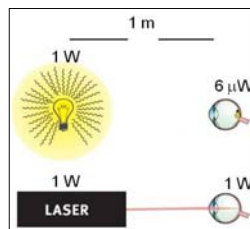
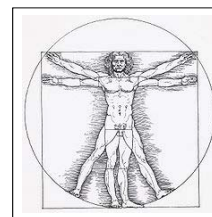

© V. Blazek, MedIT, 2017
All rights reserved
Lecture 3, Page 2

Scriptum AOM: Applied Optoelectronics in Medicine

RWTHAACHEN
UNIVERSITY

What is metrology ?

Metrology is defined by the International Bureau of Weights and Measures (BIPM) as "the science of measurement, embracing both experimental and theoretical determinations at any level of uncertainty in any field of science and technology".

Metrology includes also all aspects of measurement. The word comes from Greek μέτρον (*metron*), "measure" and "λόγος" (*logos*), amongst others meaning "speech, oration, discourse, quote, study, calculation, reason".

In Ancient Greek the term μετρολογία (*metrologia*) meant "theory of ratios".

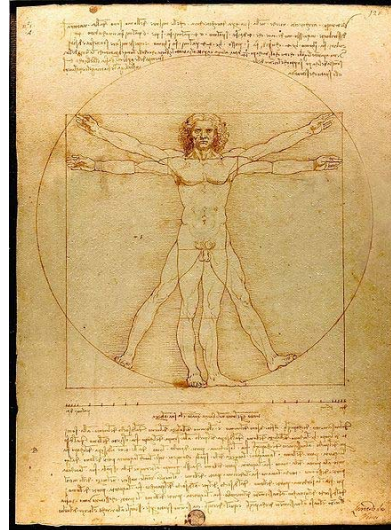

Origin of all dimensions:
The **Vitruvian Man**
(drawing created by Leonardo da Vinci
circa 1490)

What is optoelectronics?

Optoelectronics is the study and application of electronic devices that source, detect and control light, usually considered a sub-field of photonics. In this context, *light* often includes invisible forms of radiation such as gamma rays, X-rays, ultraviolet and infrared, in addition to visible light.

Optoelectronic devices are electrical-to-optical or optical-to-electrical transducers, or instruments that use such devices in their operation. *Electro-optics* is often erroneously used as a synonym, but is in fact a wider branch of physics that deals with all interactions between light and electric fields, whether or not they form part of an electronic device.

Optoelektronik Schnittstelle zwischen Optik und Elektronik

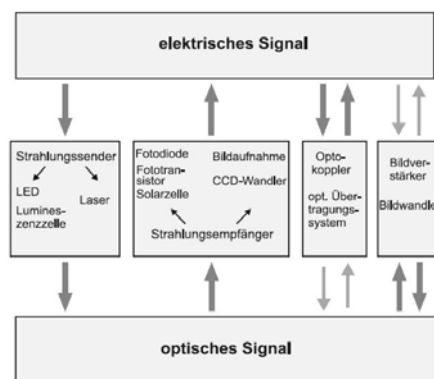

Remember:

The term optoelectronics connotes devices or circuits that comprise both electrical and optical functions.

What is photonics?

The word photonics is derived from the Greek word "photos" meaning light; it appeared in the late 1960s to describe a research field whose goal was to use light to perform functions, that traditionally fell within the typical domain of electronics, such as telecommunications, information processing, etc. Photonics as a field began with the invention of the laser in 1960. Though coined earlier, the term photonics came into common use in the 1980s as fiber-optic data transmission was adopted by telecommunications network operators. In a broader sense it is today in use also for "nonclassical optical technologies" (eg biophotonics).

The term **biophotonics** denotes a combination of biology and photonics, with photonics being the science and technology of generation, manipulation, and detection of photons, quantum units of light. It can also be described as the "development and application of optical techniques, particularly imaging, to the study of biological molecules, cells and tissue". One of the main benefits of using optical techniques which make up biophotonics is that they preserve the integrity of the biological cells being examined. Biophotonics has therefore become the established general term for all techniques that deal with the interaction between biological items and photons.

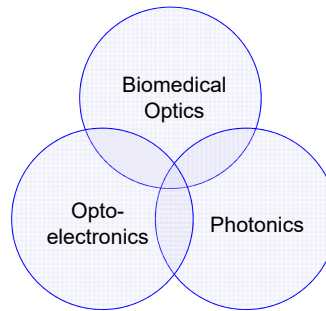

© V. Blazek, MedIT, 2017
All rights reserved
Lecture 3, Page 5

Scriptum AOM: Applied Optoelectronics in Medicine

RWTHAACHEN
UNIVERSITY

Periodic events in space and time: Vibrations and waves

Remember:

- Oscillations are periodic processes in time (e.g. pendulum, molecular vibration)
- Harmonic oscillations are periodic processes, which magnitude follows a sinusoidal function.
- Waves are periodic processes in time and space (e.g. water waves, light waves)

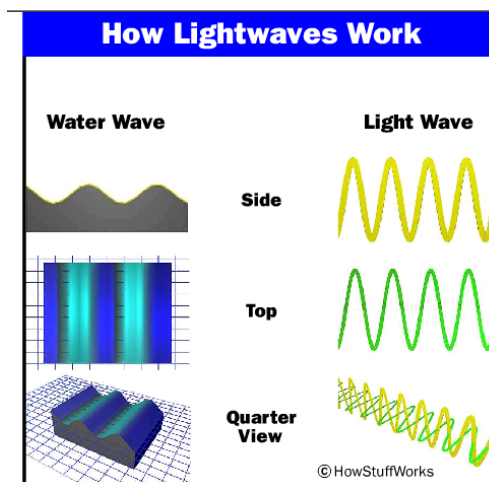

© V. Blazek, MedIT, 2017
All rights reserved
Lecture 3, Page 6

Scriptum AOM: Applied Optoelectronics in Medicine

RWTHAACHEN
UNIVERSITY

Example: Damped / non-damped transverse wave

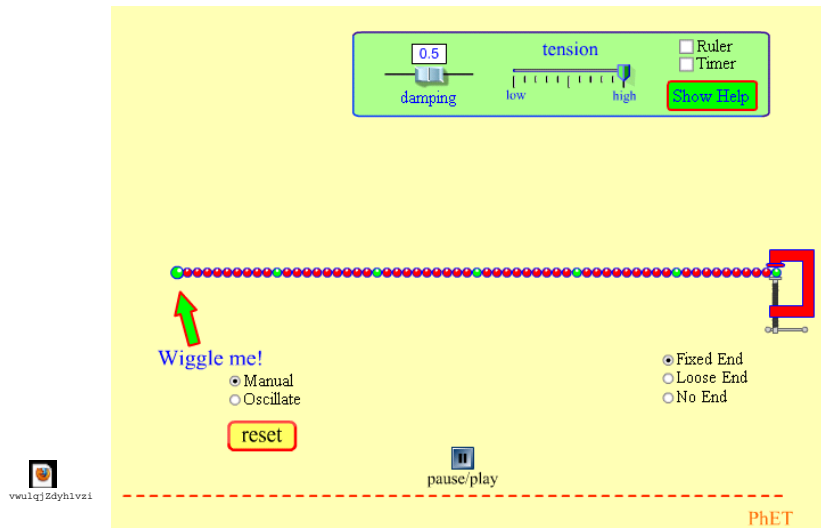

© V. Blazek, MedIT, 2017
All rights reserved
Lecture 3, Page 7

Scriptum AOM: Applied Optoelectronics in Medicine

RWTHAACHEN
UNIVERSITY

Metrological aspects of optoelectronics

Radiation intensity, radiometry, photometry, physiological optics

Radiant flux

Radiant energy per unit time, also called radiant power.

$$\Phi = \frac{dW}{dt}; \quad [\Phi] = W(\text{watt})$$

Poynting vector

The magnitude of the Poynting vector describes the radiant energy, that is transported perpendicular to the surface unit area per unit time..

$$\vec{S} = \vec{E} \times \vec{H}; \quad \left[\vec{S} \right] = \frac{W}{m^2}$$

Propagation of elektromagnetic waves in vacuum ($\epsilon_r=1$; $\mu_r=1$) :

$$\left| \vec{S} \right| = \left| \vec{E} \right| \cdot \left| \vec{H} \right| = \sqrt{\frac{\epsilon_0}{\mu_0}} \cdot \left| \vec{E} \right|^2 = \left| \vec{E} \right|^2 / Z_0 \quad \text{with} \quad E = E_0 \cdot \cos(\vec{k} \cdot \vec{r} - \omega t); \quad [E] = \frac{V}{m}$$

© V. Blazek, MedIT, 2017
All rights reserved
Lecture 3, Page 8

Scriptum AOM: Applied Optoelectronics in Medicine

RWTHAACHEN
UNIVERSITY

Radiant intensity

For a plane linearly polarized wave, propagating in the +z direction is:

$$E = E_0 \cos(kz - \omega t)$$

For the high optical frequencies (from practical reasons) we introduce a scalar, time-averaged magnitude: the **radiation intensity I**. (Irradiance or radiant flux density.)

$$I = \langle |\vec{S}| \rangle; \quad [I] = \frac{W}{m^2}$$

Relation between the radiation intensity and the electric field strength:

$$I = \langle |\vec{S}| \rangle = \frac{1}{T} \int_0^T |\vec{S}| dt; \quad T = \frac{2\pi}{\omega}$$

$$I = \sqrt{\frac{\epsilon_0}{\mu_0}} \langle |\vec{E}|^2 \rangle = \frac{1}{T} \sqrt{\frac{\epsilon_0}{\mu_0}} \int_0^T E_0^2 \cos^2(kz - \omega t) dt$$

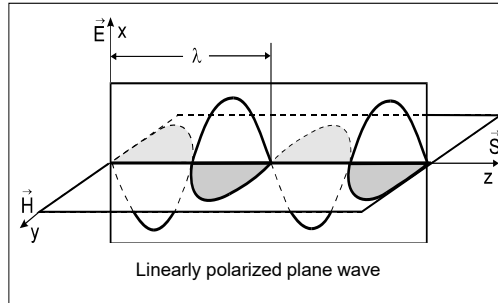

After performing integration for $z = 0$, we obtain an expression, where the radiation intensity is proportional to the square of the amplitude of the electric field strength..

$$I = \frac{1}{2} E_0^2 \sqrt{\frac{\epsilon_0}{\mu_0}} = \frac{1}{2} c_0 \epsilon_0 E_0^2; \quad c_0 = \frac{1}{\sqrt{\epsilon_0 \mu_0}} \quad c_0 \dots \text{Light speed in vacuum}$$

Fill in the values of permittivity and permeability of vacuum:

$$\epsilon_0 = 8,854 \cdot 10^{-12} \frac{As}{Vm} \quad \text{und} \quad \mu_0 = 1,2566 \cdot 10^{-6} \frac{Vs}{Am}$$

it gives the light speed in vacuum:

$$c_0 = 2,998 \cdot 10^8 \text{ms}^{-1}$$

In all matter other than vacuum, light propagates slower

Remember: The product of ϵ_0 and μ_0 has purely mechanical dimension (reciprocal value of velocity).
The „quotient“ of μ_0 mit ϵ_0 has purely electrical dimension (resistance).

Speed of light c, frequency f, wave number ρ

$$c = \frac{1}{\sqrt{\epsilon_0 \epsilon_r \mu_0 \mu_r}}; \quad \mu_r = 1$$

$$\lambda = \frac{c}{f} = \frac{1}{\rho}$$

Absolute refraction-index:

$$n = \frac{c_0}{c} = \sqrt{\epsilon_r}$$

Radiation intensity in optically dense matter
(mit $\epsilon_r > 1$ and $\mu_r = 1$)
and applying the rule:

$$\vec{E} = \text{Re} \left\{ \dot{\vec{E}} \right\}$$

$$I = \frac{1}{2} c_0 \epsilon_0 n E_0^2 = \frac{1}{2} c_0 \epsilon_0 n \left\langle \dot{\vec{E}} \dot{\vec{E}}^* \right\rangle$$

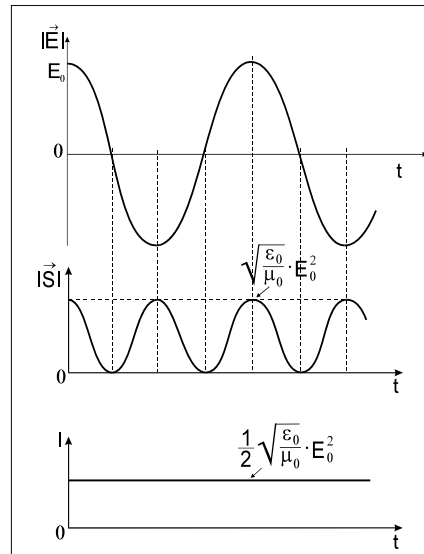

© V. Blazek, MedIT, 2017
All rights reserved
Lecture 3, Page 11

Scriptum AOM: Applied Optoelectronics in Medicine

RWTH AACHEN
UNIVERSITY

History of measuring the speed of light

- 1) **Galileo Galilei** attempted in 16th century to measure the speed of light, in which he positioned two men with lanterns on mounds at 100 meters distance to each other...



- 2) **Ole Roemer** discovered in 1676, by observing the moons of Jupiter, that the time between the eclipses grew up, when the Earth became more distant ...



© V. Blazek, MedIT, 2017
All rights reserved
Lecture 3, Page 12

Scriptum AOM: Applied Optoelectronics in Medicine

RWTH AACHEN
UNIVERSITY

Increased accuracy of c and redefinition of the meter and second

In the second half of the 20th century much progress was made in increasing the accuracy of measurements of the speed of light, first by cavity resonance techniques and later by laser interferometer techniques. These were aided by new, more precise, definitions of the meter and second. In 1960, the meter was redefined in terms of the wavelength of a particular spectral line of krypton-86, and, in 1967, the second was redefined in terms of the hyperfine transition frequency of the ground state of caesium-133.

In 1972, using the laser interferometer method and the new definitions, a group at NBS in Boulder, Colorado determined the speed of light in vacuum to be $c = 299\,792\,456.2 \pm 1.1$ m/s. This was 100 times less uncertain than the previously accepted value. The remaining uncertainty was mainly related to the definition of the meter. As similar experiments found comparable results for c , the 15th Conférence Générale des Poids et Mesures (CGPM) in 1975 recommended using the value 299 792 458 m/s for the speed of light.

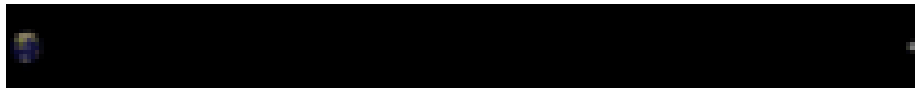

A beam of light is depicted travelling between the Earth and the Moon in the time it takes a light pulse to move between them: 1.255 seconds at their mean orbital (surface-to-surface) distance. The relative sizes and separation of the Earth-Moon system are shown to scale.
From: http://en.wikipedia.org/wiki/Speed_of_light

For real light sources

(inhomogeneous distribution of radiation intensity over an area perpendicular to the propagation, time-dependent intensity variation (modulation)) is:

$$I = I(x, y, t); \quad z = \textit{konst.}$$

$$\Phi(t) = \int_{S_{\perp}} I(x, y, t) dS_{\perp}$$

$$\bar{I}(t) = \frac{\Phi(t)}{S_{\perp}}$$

Remember: The time dependence of the radiation intensity and the radiation flux in the formula does not mean the optical carrier frequency. Optical detectors (including the eye) evaluate the radiant flux.

Radiant energy quantities

Radiant energy

$$W = \int_{\Delta t} \Phi dt; \quad [W] = J$$

Radiant energy volume density:

$$w = \frac{dW}{dV}; \quad [w] = \frac{J}{m^3}$$

$$w = \frac{dW}{dS_{\perp} c dt} = \frac{I}{c}$$

dS_{\perp} is a cross-section of an elementary cylinder of length $c dt$

Spectral radiant density of volume V :

$$W = \int_V w \cdot dV$$

Spectral radiant energy:

$$W_{\lambda} = \frac{dW}{d\lambda}; \quad [W_{\lambda}] = \frac{J}{m}$$

Remember: All radiometric and photometric quantities based on unitary wavelength interval are referred to as "spectral".

Radiant energy in a wavelength interval:

$$W = \int_{\lambda_1}^{\lambda_2} W_{\lambda}(\lambda) d\lambda.$$

Irradiance E and radiant exitance M

$$M \text{ oder } E = \frac{d\Phi}{dA}; \quad [M \text{ oder } E] = \frac{W}{m^2}$$

Radiant intensity

$$I_i = \frac{d\Phi}{d\Omega}; \quad [I_i] = \frac{W}{sr}$$

Solid angle Ω

$$\Omega = \frac{A}{r^2} \cdot \Omega_0 \quad \text{mit}$$

$\Omega_0 = 1 \text{ sr}$ (Steradian) ... unit solid angle

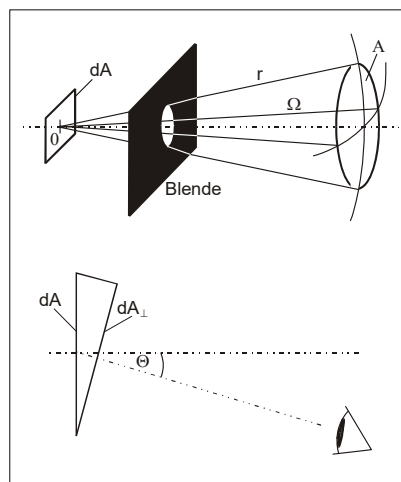

Radiation in all directions: $\Omega_G = 4\pi \text{ sr}$

Effective radiant area:

$$dA_{\perp} = dA \cdot \cos \Theta$$

Radiance L:

$$L = \frac{d^2 \Phi}{dA d \Omega \cos \Theta} = \frac{dI_i}{dA \cos \Theta}; [L] = \frac{W}{m^2 sr}$$

Specific case: Lambert-Area

$$I_i(\Theta) = I_i(0) \cos \Theta$$

$$L(\Theta) = \frac{dI_i(0)}{dA} = konst.$$

$$M = \pi L$$

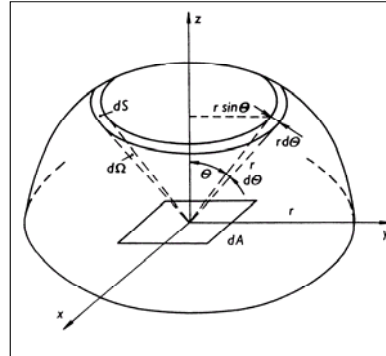

Spectral sensitivity:

Evaluation of optical radiation by a receiver

(DIN 5031, Blatt 2)

Input variable x with $dx = x_{\lambda} \cdot d_{\lambda}$ (e.g. radiant flux)

output variable y with $dy = y_{\lambda} \cdot d_{\lambda}$ (e.g. photocurrent of the detector)

(Index λ means: "spectral density of the variable")

Absolute spectral sensitivity:

$$s(\lambda) = \frac{dy}{dx}; s(\lambda) = \frac{y}{x}$$

Relative spectral sensitivity:

$$s(\lambda)_{rel} = \frac{s(\lambda)}{s(\lambda_0)}$$

Remember: Most of the optical radiation detectors have a nonlinear receiver characteristics (spectral sensitivity curve)

Spectral sensitivity of a silicon photodiode

Theoretically maximal absolute spectral sensitivity (one received photon generates exactly one electron) is:

$$\frac{s(\lambda)_{\max}}{\frac{mA}{mW}} = \frac{I_{ph}}{\Phi} = \frac{e}{h \cdot c} \lambda = \frac{\lambda}{1240}$$

with $e=1,6 \cdot 10^{-19} \text{ As}$, $c=3 \cdot 10^8 \text{ ms}^{-1}$ u. $h=6,626 \cdot 10^{-34} \text{ Js}$

Absorption edge of Silicon
(with $E_{Si} = 1,1 \text{ eV}$):

$$\lambda_{\max, Si} = \frac{c \cdot h}{E_{Si}} = 1.127,17 \text{ nm}$$

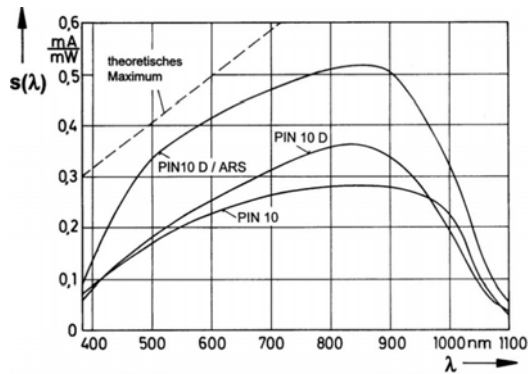

© V. Blazek, MedIT, 2017
All rights reserved
Lecture 3, Page 19

Scriptum AOM: Applied Optoelectronics in Medicine

RWTHAACHEN
UNIVERSITY

Different light detectors (photodiodes) and their spectral sensitivity

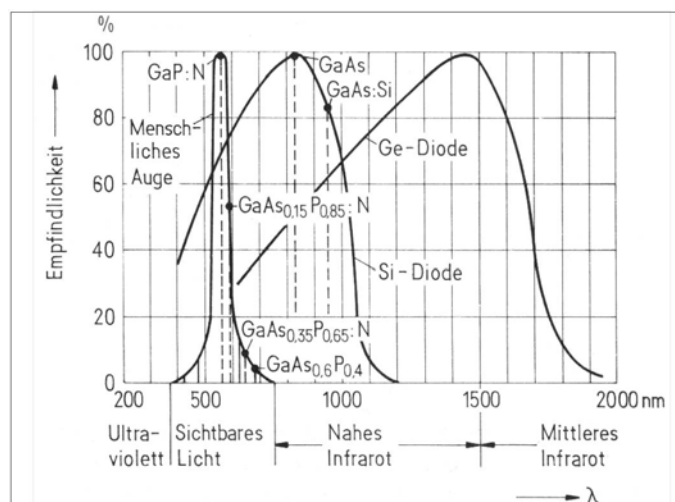

© V. Blazek, MedIT, 2017
All rights reserved
Lecture 3, Page 20

Scriptum AOM: Applied Optoelectronics in Medicine

RWTHAACHEN
UNIVERSITY

Different light detectors (photodiodes) for optoelectronic sensors



© V. Blazek, MedIT, 2017
All rights reserved
Lecture 3, Page 21

Scriptum AOM: Applied Optoelectronics in Medicine

RWTH AACHEN
UNIVERSITY

Different light emitters (LEDs) for optoelectronic sensors

Typical "hardware" form and radiation characteristic

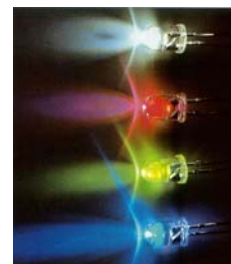
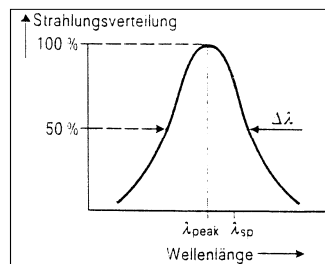
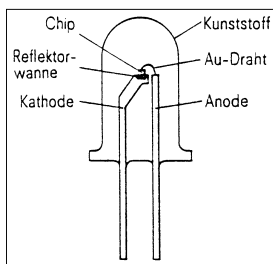

Farbe	Wellenlänge nm	Substrat	E_g eV	Aktive Schicht
Infrarot	950	GaAs	1,4	GaAs:Si
Infrarot	800 bis 900	GaAs	1,4	GaAlAs
Rot	700	GaP	2,3	GaP:ZnO
Standardrot	660	GaAs	1,4	GaAs _{0,6} P _{0,4}
Superrot	635	GaP	2,3	GaAs _{0,35} P _{0,65} :N TSN
Gelb	590	GaP	2,3	GaAs _{0,15} P _{0,85} :N TSN
Grün	565	GaP	2,3	GaP:N
Blau	480	SiC	2,8	SiC

TSN steht für Transparent Substrate Nitrogen (doped)

© V. Blazek, MedIT, 2017
All rights reserved
Lecture 3, Page 22

Scriptum AOM: Applied Optoelectronics in Medicine

RWTH AACHEN
UNIVERSITY

Basics of physiological optics

Optical radiation spectra bands

		Wavelength range [nm]	Frequency range [THz]
Ultraviolet radiation	UV-A	100 - 280	3000 - 1071
	UV-B	280 - 320	1071 - 937,5
	UV-C	320 - 380	937,5 - 789,5
Visible radiation (light)	violet	380 - 430	789,5 - 697,6
	blue	430 - 485	697,6 - 618,5
	green	485 - 560	618,5 - 535,7
	yellow	560 - 585	535,7 - 512,8
	orange	585 - 615	512,8 - 487,8
	red	615 - 780	487,8 - 384,6
Infrared radiation	IR-A	780 - 1400	884,6 - 214,3
	IR-B	1400 - 3000	214,3 - 100,0
	IR-C	3000 - $1 \cdot 10^6$	100,0 - 0,3

© V. Blazek, MedIT, 2017
All rights reserved
Lecture 3, Page 23

Scriptum AOM: Applied Optoelectronics in Medicine

RWTHAACHEN
UNIVERSITY

The human eye as a high sensitivity photodetector

From optical point of view is our eye a transparent imaging device, with favored interactions on the **retina**

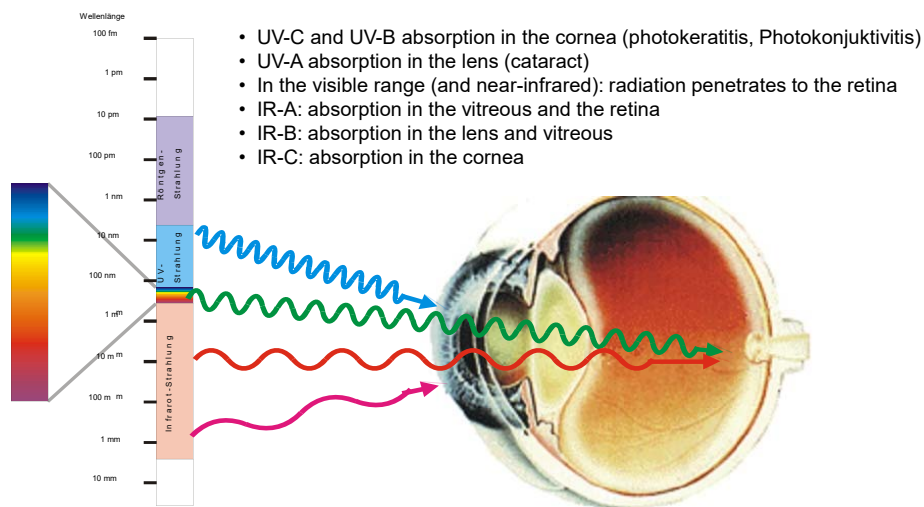

© V. Blazek, MedIT, 2017
All rights reserved
Lecture 3, Page 24

Scriptum AOM: Applied Optoelectronics in Medicine

RWTHAACHEN
UNIVERSITY

First documented speculations on the nature of light perception

The optics developed initially out of the natural philosophical issues in Greek antiquity about the nature of vision and color perception

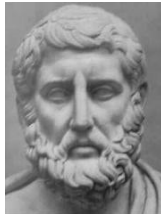

EMPEDOCLES (490 - 435 v. Chr.):
Theorie der Entwicklung des Lebens

"Objekt sendet Licht aus, erreicht Auge und kehrt zurück"

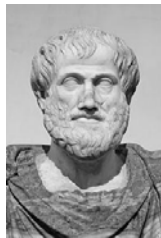
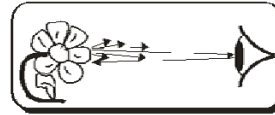

ARISTOTELES (384 - 322 v. Chr.):
Theorie der größtmöglichen Vollkommenheit

"Lichtstrahlen werden vom Auge gesendet, beleuchten Objekt und kehren zurück"

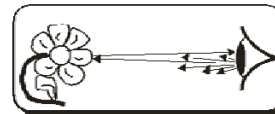

ALHAZEN (Ibn Al Haitham; 965 - 1039):
Theorie der Augenfunktion als Lichtdetektor

"Lichtstrahlen haben ihren Ursprung im Objekt, nicht im Auge"

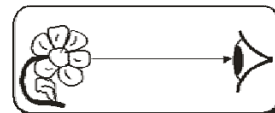

© V. Blazek, MedIT, 2017
All rights reserved
Lecture 3, Page 25

Scriptum AOM: Applied Optoelectronics in Medicine

RWTHAACHEN
UNIVERSITY

The human eye as a photodetector array

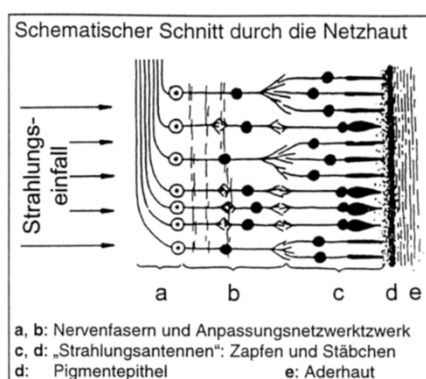
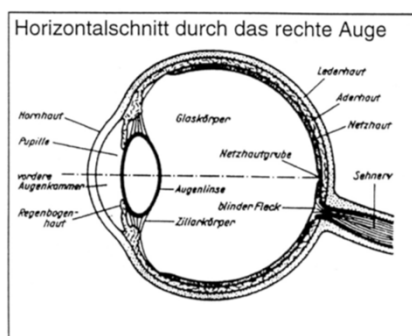

The human optic/visual organ works like a computer system. The eye acts as a radiation detector, the brain as a calculator. The light and color perception is the output.

The retina is a receiver with multiple detectors on the surface. With 110 to 125 million **rods** (diameter 3 mm) and 4-7 million **cones** (diameter 4 mm) in the middle.

© V. Blazek, MedIT, 2017
All rights reserved
Lecture 3, Page 26

Scriptum AOM: Applied Optoelectronics in Medicine

RWTHAACHEN
UNIVERSITY

The human eye as a optical device

horizontal section through the right eye

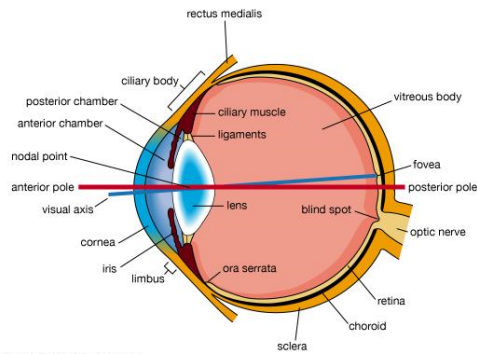

© 2013 Encyclopædia Britannica, Inc.

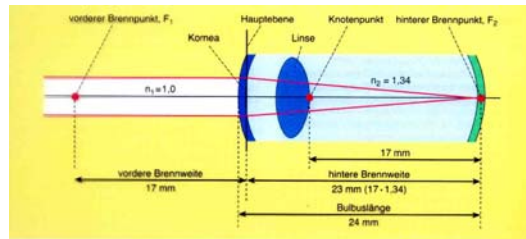

© V. Blazek, MedIT, 2017
All rights reserved
Lecture 3, Page 27

Scriptum AOM: Applied Optoelectronics in Medicine

RWTHAACHEN
UNIVERSITY

Something remarkable to our eyes

Hermann von Helmholtz (08.31.1821 - 08.09.1894)

German physiologist and physicist, once said he would fire an optician, who would bring him an instrument like the human eye, and yet not being able to recreate one.

The contouring and centering of the image-forming surfaces (cornea and lens) are even worse than a cheap camera, the aberrations are not adequately optically corrected..., but all these weaknesses are excellently compensated by sophisticated neuronal control mechanisms.

Together with the exceeding sensitivity range (brightness range) which is greater than those of any physical device (15%).

The eye is constantly listening and adopts its sensitivity and angular-dependent reception characteristics through the endogenous accommodative function automatically - like a Polaroid color film pack with a few milliseconds development time that switches automatically from 10 to 40 DIN

© V. Blazek, MedIT, 2017
All rights reserved
Lecture 3, Page 28

Scriptum AOM: Applied Optoelectronics in Medicine

RWTHAACHEN
UNIVERSITY

Schema of the complex neuronal network in retina

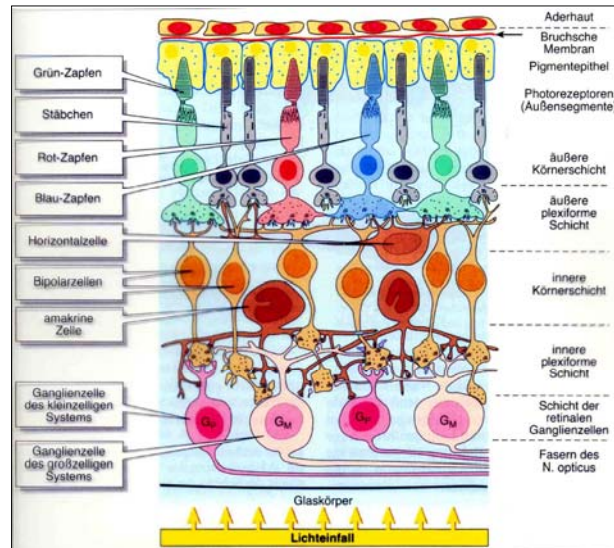

© V. Blazek, MedIT, 2017
All rights reserved
Lecture 3, Page 29

Scriptum AOM: Applied Optoelectronics in Medicine

RWTHAACHEN
UNIVERSITY

Signal & color coding and data transfer in human neural system

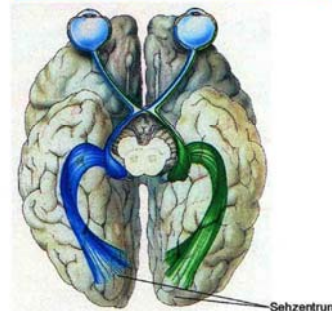
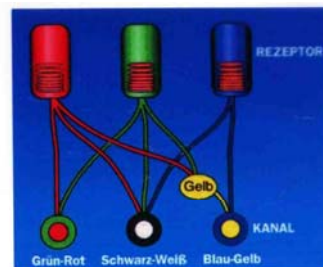
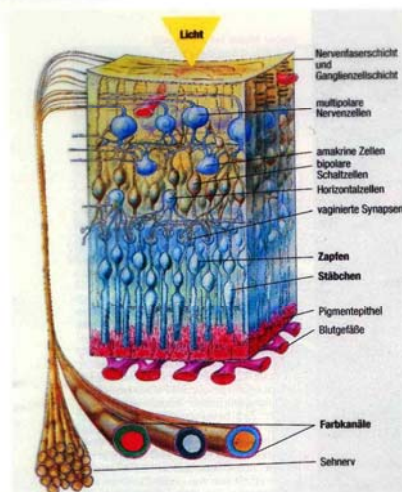

© V. Blazek, MedIT, 2017
All rights reserved
Lecture 3, Page 30

Scriptum AOM: Applied Optoelectronics in Medicine

RWTHAACHEN
UNIVERSITY

Spectral sensitivity of retina detectors (rods and cones)

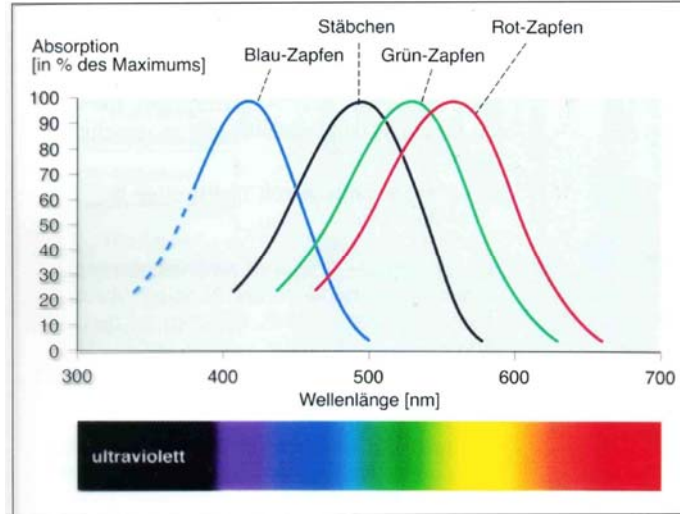

© V. Blazek, MedIT, 2017
All rights reserved
Lecture 3, Page 31

Scriptum AOM: Applied Optoelectronics in Medicine

RWTH AACHEN
UNIVERSITY

Light sensitivity characteristics of the human eye (so called standard observer according to DIN 5033)

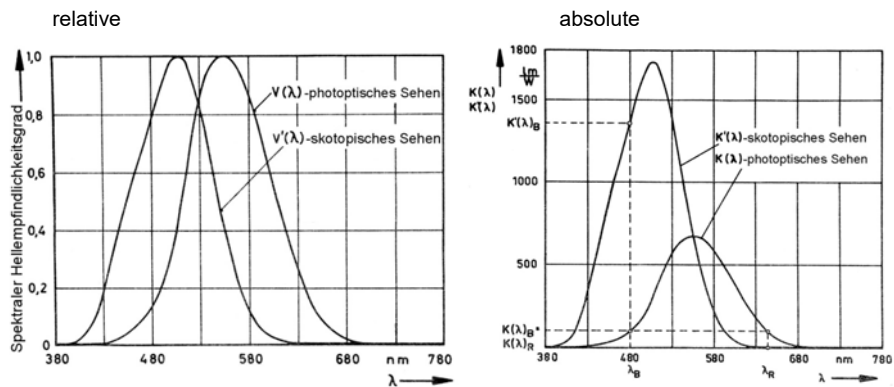

© V. Blazek, MedIT, 2017
All rights reserved
Lecture 3, Page 32

Scriptum AOM: Applied Optoelectronics in Medicine

RWTH AACHEN
UNIVERSITY

Ultimate sensitivity of the human eye

Three conditions:

- 5 photons of the same wavelength 500 nm,
- absorbed at exactly the same place on retina
- within 1ms

$$\sim 4 \times 10^{-16} \text{ W}$$

In technical world, such sensitivity can be achieved only with special and expensive SPAD detectors.

10 aW:

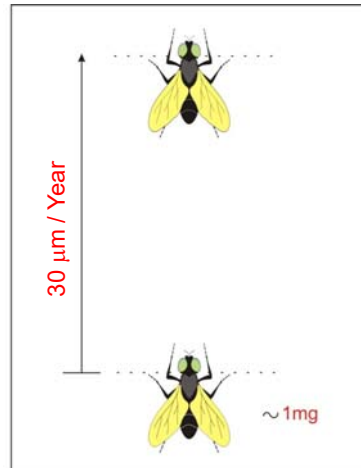

© V. Blazek, MedIT, 2017
All rights reserved
Lecture 3, Page 33

Scriptum AOM: Applied Optoelectronics in Medicine

RWTHAACHEN
UNIVERSITY

Predecessor models of the human eye in the animal kingdom: from light-dark perception of individual sensory cells to the eye

In the animal kingdom, there are many different types of eyes. Some are quite sophisticated, others in a very low development stage. Here we present some examples of these sense organs. According to their construction, they are well suited to different perception tasks. The highly developed eye of vertebrates seems to be a meaningful development of the precursors.

According to the theory of Nilsson and PELG (1994), the eye has developed from a flat light-sensitive Layer. The initial structure consists of a flat light-sensitive layer (green), which is located above a pigment layer (dark blue). The photosensitive layer is protected by a transparent cover (yellow).

The adjacent animation presents, in simplified manner, the transition to the lens-eye.

Start 



dxjhs1vzi

NILSSON, D., PELGER, S: A pessimistic estimate of the time required for an eye to evolve. Proc. R. Soc. Lond. B 256 (1994), 53-58
Quelle: http://leifi.physik.uni-muenchen.de/web_ph07_g8/umwelt_technik/02augen/teraugen.htm

© V. Blazek, MedIT, 2017
All rights reserved
Lecture 3, Page 34

Scriptum AOM: Applied Optoelectronics in Medicine

RWTHAACHEN
UNIVERSITY

Predecessor models of the human eye in the animal kingdom: Earthworm

Many invertebrates are capable of light-dark perception only. The earthworm, for example, has many photoreceptor cells incorporated into the skin-layer. On this way, it can determine whether it is exposed to light or not. One could believe that the earthworm, which is normally underground, does not need to see at all. But if its photoreceptor cells respond, it is a signal of danger. It means to it, an exposure to daylight and there is a risk of being eaten by birds. **The light sense of the earthworm is comparable to the human heat perception.**

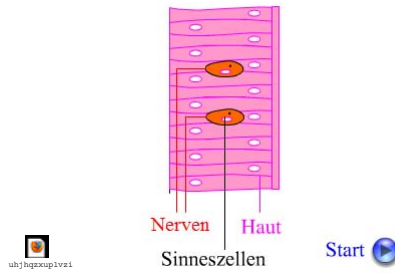

Quelle: http://leifi.physik.uni-muenchen.de/web_ph07_g8/umwelt_technik/02augen/tieraugen.htm

© V. Blazek, MedIT, 2017
All rights reserved
Lecture 3, Page 35

Scriptum AOM: Applied Optoelectronics in Medicine

RWTHAACHEN
UNIVERSITY

Predecessor models of the human eye in the animal kingdom: Limpet

In higher developed animals, the light-sensitive cells can be found concentrated at certain spots together. This increases sensitivity to light. For better protection these spots, they converted to kind of grooves. The limpets are for example equipped with such grooves. The spots can be excited with light from certain direction only. This is controlled by arrangement of these Photo-cells. (See animation). On this way, **the sense of direction** could develop. Since there is no projection of a point on surface the "groove" eye (Napfauge), there is **no image impression possible**.

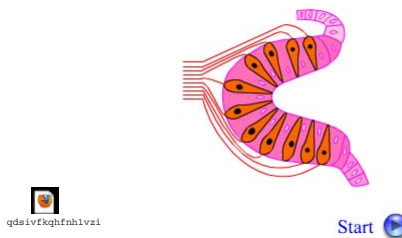

Quelle: http://leifi.physik.uni-muenchen.de/web_ph07_g8/umwelt_technik/02augen/tieraugen.htm

© V. Blazek, MedIT, 2017
All rights reserved
Lecture 3, Page 36

Scriptum AOM: Applied Optoelectronics in Medicine

RWTHAACHEN
UNIVERSITY

Predecessor models of the human eye in the animal kingdom: Nautilus

By tentacle marine creatures e.g. the Nautilus, the grooves (foveae) are grown almost to a ball. There is an image projection on the photo-sensitive tissue in the groove through the small opening, similar to a simple pinhole camera.

If the hole opens, the image becomes brighter, if the opening closes the image gets sharp but dark.

Beside the **light-dark** perception and **direction** sense, the pinhole-eye enables a simple **image projection**.

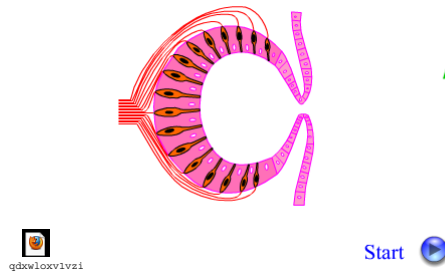

Quelle: http://leifi.physik.uni-muenchen.de/web_ph07_g8/umwelt_technik/02augen/tieraugen.htm

© V. Blazek, MedIT, 2017
All rights reserved
Lecture 3, Page 37

Scriptum AOM: Applied Optoelectronics in Medicine

RWTHAACHEN
UNIVERSITY

Predecessor models of the human eye in the animal kingdom: Burgundy snail (*Helix pomatia*)

The pinhole-eye creates a sharp image only if the hole is very small. But this decreases the image brightness.

Here the nature needed a trick: Development of a **lens**, probably through thickening of the fluid located in the groove. Now, despite large aperture, with the lens it was possible to get a **sharp and bright image** projection.

The Burgundy snail has such a lens eye.

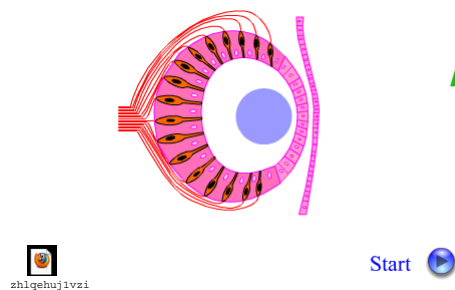

Quelle: http://leifi.physik.uni-muenchen.de/web_ph07_g8/umwelt_technik/02augen/tieraugen.htm

© V. Blazek, MedIT, 2017
All rights reserved
Lecture 3, Page 38

Scriptum AOM: Applied Optoelectronics in Medicine

RWTHAACHEN
UNIVERSITY

Is the human eye an optimal imaging system?

Examples from the animal kingdom:

Four eyes for two worlds

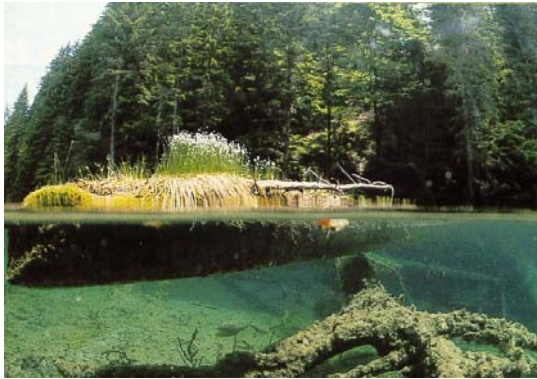

© V. Blazek, MedIT, 2017
All rights reserved
Lecture 3, Page 39

Scriptum AOM: Applied Optoelectronics in Medicine

RWTHAACHEN
UNIVERSITY

Is the human eye an optimal imaging system?

Examples from the animal kingdom:

Eight eyes can see more



© V. Blazek, MedIT, 2017
All rights reserved
Lecture 3, Page 40

Scriptum AOM: Applied Optoelectronics in Medicine

RWTHAACHEN
UNIVERSITY

Is the human eye an optimal imaging system?

Examples from the animal kingdom:

Proverbial eagle eyes



© V. Blazek, MedIT, 2017
All rights reserved
Lecture 3, Page 41

Scriptum AOM: Applied Optoelectronics in Medicine

RWTHAACHEN
UNIVERSITY

Is the human eye an optimal imaging system?

Examples from the animal kingdom:

Panoramic view of insects

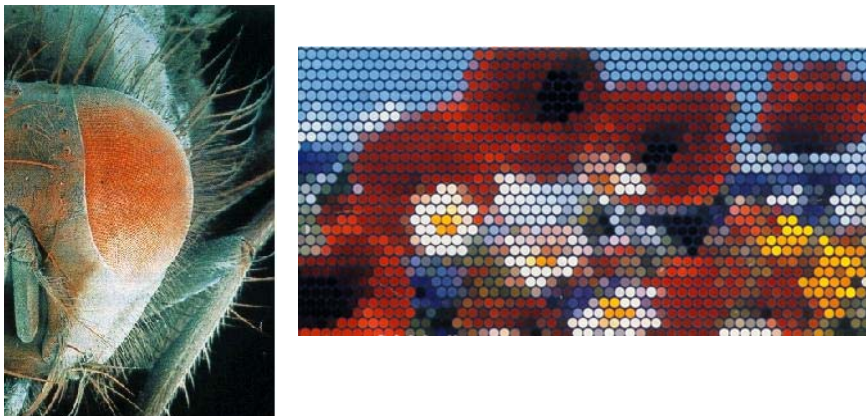

© V. Blazek, MedIT, 2017
All rights reserved
Lecture 3, Page 42

Scriptum AOM: Applied Optoelectronics in Medicine

RWTHAACHEN
UNIVERSITY

Performance comparison of the human lens – eye and the complex eye of a fly



Should we preserve the aspect ratio...

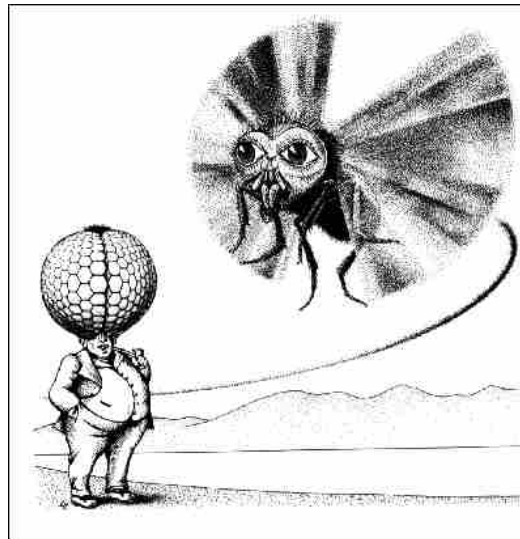

Aus: Kuno KIRSCHFELD, Naturwissenschaftliche Rundschau 9 (1984), 352-362

© V. Blazek, MedIT, 2017
All rights reserved
Lecture 3, Page 43

Scriptum AOM: Applied Optoelectronics in Medicine

RWTHAACHEN
UNIVERSITY

Colour comparison human / bee / fish

Human:

3 cones – photoreceptors with maximal absorption at 419, 531 und 559 nm

Bee:

3 cones – photoreceptors with maximal absorption at 340, 440 und 540 nm

Fish:

4 cones – photoreceptors with maximal absorption at 360, 450, 530 und 620 nm (**tetrachromatic vision**)

Remember:

The ability of color perception is mostly examined by drill experiments

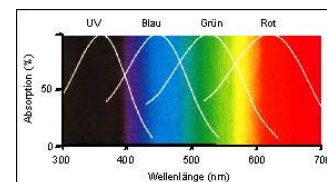
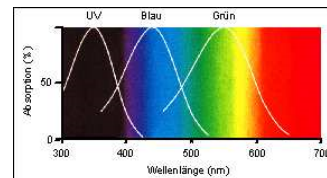
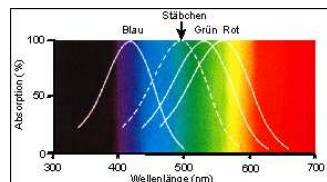

© V. Blazek, MedIT, 2017
All rights reserved
Lecture 3, Page 44

Scriptum AOM: Applied Optoelectronics in Medicine

RWTHAACHEN
UNIVERSITY

By the way ... How good can snakes see?

Snakes are cold-blooded animals and take the body temperature of their surroundings. The strongest sense is the smell. The "nose" of snakes is built up from the tongue and so-called Jacob's bodies (sense pits in roof of the mouth). Thus.. snakes "smell" with their tongues. Snakes are almost deaf - they have an external ear and no eardrum - and they can badly see. Usually they "locate" with a pit organ as an infrared sensor.

Physically: Temperature resolution 0,003° C (!)
Biologically: Identification even in total darkness



http://www.sgipr.org/galerie/tier/schlang/schl_ueb.htm

© V. Blazek, MedIT, 2017
All rights reserved
Lecture 3, Page 45

Scriptum AOM: Applied Optoelectronics in Medicine

RWTHAACHEN
UNIVERSITY

Structure and morphology of pit organs of pit vipers (Crotalinae)



- Paired organ located between the nostril and eye
- Principle of a pinhole camera
- Two-chamber (Bicameral) system
- integrated cooling system

http://www.sgipr.org/galerie/tier/schlang/schl_ueb.htm

© V. Blazek, MedIT, 2017
All rights reserved
Lecture 3, Page 46

Scriptum AOM: Applied Optoelectronics in Medicine

RWTHAACHEN
UNIVERSITY

Fine structure of the pit organ of a snake

Cooling, two chamber system

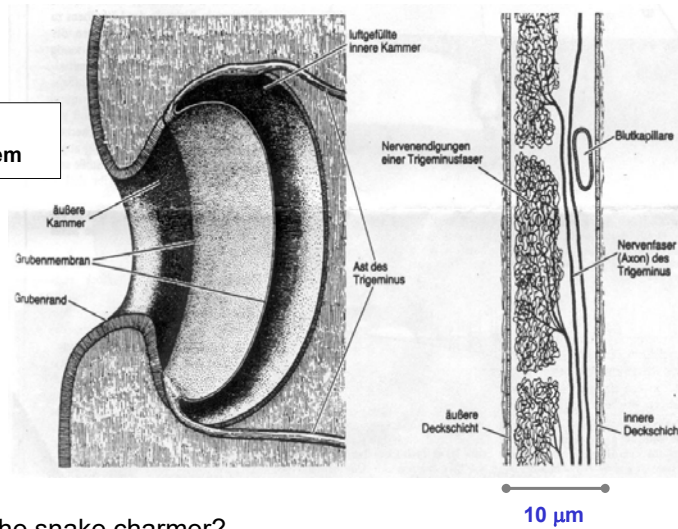

And what about the snake charmer?

From: Newman and Hartline, 1982

© V. Blazek, MedIT, 2017
All rights reserved
Lecture 3, Page 47

Scriptum AOM: Applied Optoelectronics in Medicine

RWTH AACHEN
UNIVERSITY

Citát pro třetí přednášku / Quotation of the lecture 3:

„Mehr Licht“
„More light“



Johann Wolfgang von GOETHE
(22. 3. 1832)

© V. Blazek, MedIT, 2017
All rights reserved
Lecture 3, Page 48

Scriptum AOM: Applied Optoelectronics in Medicine

RWTH AACHEN
UNIVERSITY